

Nikon

Automatic Levels

AS-2 / AS-2C

Instruction Manual

Thank you for purchasing the Nikon automatic levels AS-2/AS-2C. The AS-2/AS-2C is designed for high precision surveys in civil engineering and architectural construction. Leveling of the instrument can be easily attained by rough adjustment, enabling uniform surveying accuracy with no sighting errors. Moreover, the waterproof telescope allows you to use the instrument even in moist circumstances such as in rain or in tunnel construction. The AS-2C is identical to the AS-2 except that it is provided with a horizontal circle.

Please read this instruction manual thoroughly to get fully acquainted with the product.

***Waterproof:**

No signs of water intrusion to the inside of the instrument after it has been left in the water for 30 minutes with its uppermost part 150mm or deeper, and its lowest part 1m or deeper below the water surface.

Nikon-Trimble reserves the right to make such alterations in design as may be considered necessary in light of experience. For this reason, specific details and illustrations in this handbook may not conform in every detail to models in current production.



CARE AND MAINTENANCE

1. When carrying

The instrument should be carried encased. If you insist on carrying it while left attached to a tripod, keep them vertical. Never support them on the shoulder.

2. Rain

The instrument can be used in the rain, but be sure to wipe off the moisture after use.

3. Storage

Store the instrument in a shady dry place.

4. Cleaning lens

Remove the smudges and finger marks from the lens using soft tissue or soft washed-out cotton cloth free from lint and grease.

5. Cleaning plastic case

Use the neutral detergent. Never use any organic solvents (such as thinner, ethyl alcohol, xylene.)

6. Cleaning horizontal circle (AS-2C only)

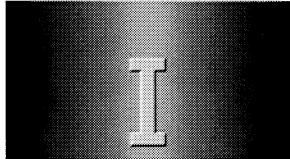
When the horizontal circle is stained or fogged up, it can be cleaned. Remove the horizontal circle cleaning window cover at the side of the instrument. Moisten the clean soft cloth with a small amount of absolute alcohol and wipe the circle from the center to the rim. Replace the cover securely.

7. Do not turn the attaching screws

Do not overturn or release the attaching screws since the firmness of the screws are all figured out to maintain the best performance of the instrument.

CONTENTS

CARE AND MAINTENANCE	ii
I. NOMENCLATURE	1
II. USAGE	3
III. CHECKING AND ADJUSTMENT	7
1. Circular level	7
2. Horizontality of the line of sight	9
IV. OPTIONAL ACCESSORIES	11
1. Plane parallel micrometer-3	11
2. Illuminator-3	14
3. Diagonal eyepiece prism	15
4. Zenith prism	15
V. SPECIFICATIONS	16

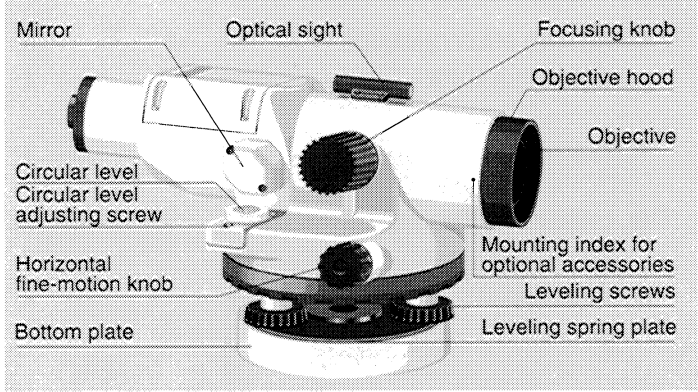


NOMENCLATURE

1. Right Side (for AS-2/AS-2C)



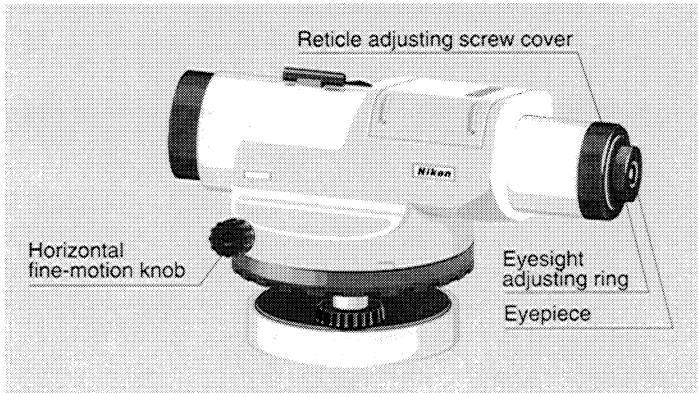
Fig. 1



2. Left Side (for AS-2)

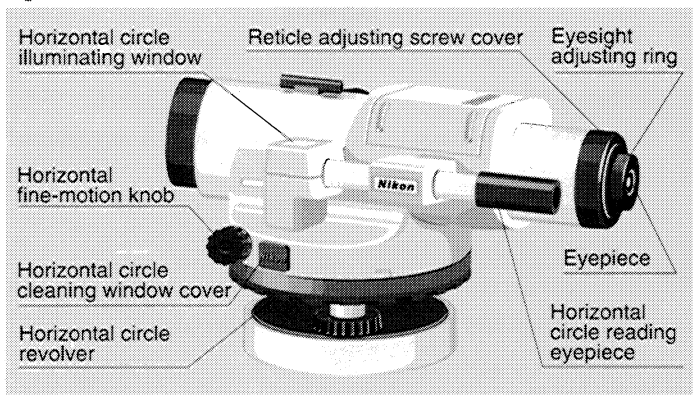


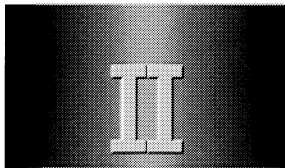
Fig. 2



3. Left Side (for AS-2C)

Fig. 3





USAGE

1. Set a tripod.

Set a tripod on the ground. Make sure that its head is approximately level.

2. Mount the instrument.

Gently take out the instrument from its plastic case. Mount it on the tripod. Secure it by the lock screw from underside.

3. Level the instrument.

The circular level shows the inclination of the instrument. When its air bubble is placed inside the brown circle, the instrument is within its automatic compensation range ($\pm 12'$). If not, adjust three leveling screws to bring the air bubble inside the brown circle.

When more accuracy is required, place the air bubble exactly at the center of the brown circle.

When spherical head tripod is used:

Slightly loosen the lock screw. Hold the bottom plate of the instrument and slide it along the spherical head to bring the air bubble inside the brown circle. Tighten the lock screw.

When more accuracy is required, place the air bubble exactly at the center of the brown circle.

4. Adjust the diopter.

Remove the objective cap and look into the eyepiece. Turn the eyesight adjusting ring to focus on the crosshairs inside the viewfield.

5. Focus on the target.

Aim on a target using the optical sight. Bring the target to the center of the viewfield using horizontal fine-motion knob. Focus on the target using focusing knob. Make sure that there is no parallax existing. (See page 5.)

6. Check the horizontality.

Check the circular level from the eyepiece side using the mirror. If the air bubble is inside the brown circle, the line of sight inside the viewfield is showing the exact horizontal line. If not, adjust the leveling screws to bring the bubble inside the circle.

7. Survey.

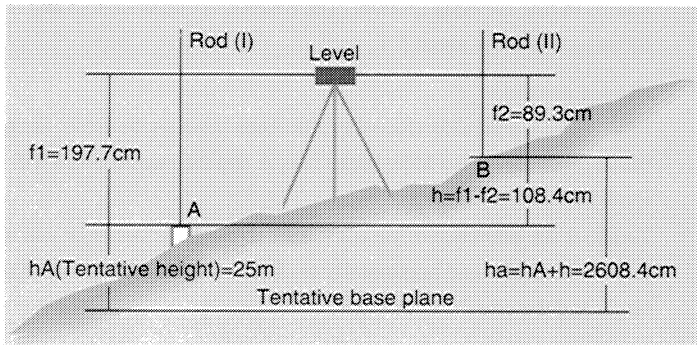
Measuring height difference between points A and B

Set the instrument halfway between points A and B and read the rods (I) and (II). The difference between the readings is the height difference.

Example:

$$\begin{aligned} & \text{Height difference between the points A and B} \\ &= \text{Reading on the rod (I)} - \text{Reading on the rod (II)} \\ &= 197.7\text{cm} - 89.3\text{cm} = 108.4\text{cm} \end{aligned}$$

Fig. 4



Measuring distance from the instrument center to the target (Stadia measurement)

Stadia lines inside the viewfield is used for distance measurement.

Read out the length ℓ on the rod imaged between the two stadia lines.

Multiply the length ℓ by 100 to get the distance L from the instrument center to the target.

Fig. 5

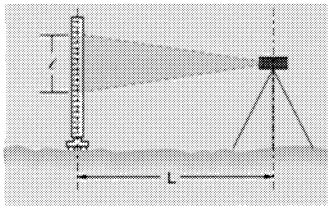
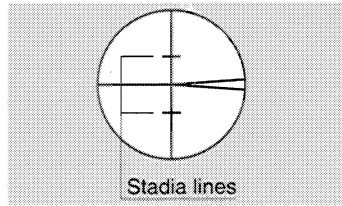


Fig. 6



•About the focusing knob

The focusing knob functions as coarse focus knob and fine focus knob. Due to this coaxial coarse/fine focusing mechanism, the rotation torque changes during rotation. When felt heavy, the knob is under coarse focusing motion and when felt light, under fine focusing motion.

The coarse/fine switching is performed automatically. The rotation starts with fine focusing motion, and switches to coarse motion after turned for approximately 120° . When turned to opposite direction, it returns to fine focusing motion. The rotation speed of coarse and fine focusing motion is about 5:1.

•About parallax

When there is a parallax (focusing difference between the crosshairs and the target), your eyes will feel deep fatigue and the measurement will show the incorrect value.

To check the existence of parallax, look through the eyepiece and move the eye vertically and horizontally to check if the relative position of the target and the crosshairs changes.

If the relative position does not change, there is no parallax.

If the relative position changes, there is a parallax. Refocus on crosshairs and the target respectively to eliminate the parallax.

•**About automatic compensation**

The adjusting mirror inside the instrument automatically compensates the inclination of the instrument body. The automatic compensation range is $\pm 12'$.

When the air bubble is inside the brown circle, the inclination of the instrument body is within $\pm 12'$, thus providing exact horizontal line of sight.

When this automatic compensating function is working correctly, the target image moves inside the viewfield when the tripod is tapped lightly.

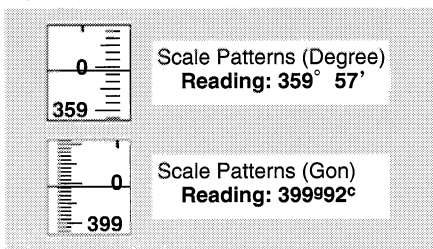
•**About horizontal circle (AS-2C only)**

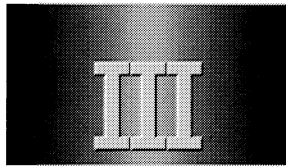
Look into the horizontal circle reading eyepiece to find the scale patterns. One division represents $10'$ or $10''$. The horizontal circle can be set at the desired position by the horizontal circle revolver.

Fig. 7



Fig. 8





CHECKING AND ADJUSTMENT

The instrument should be checked periodically to assure its best performance.



1. Circular level

The circular level axis should be set parallel to the vertical axis of the instrument.

Checking

Set the instrument so that the air bubble is at the very center of the brown circle. Turn the telescope 180° and check if the air bubble is not moving away from the center of the brown circle. If it does, adjustment is needed.

Fig. 9

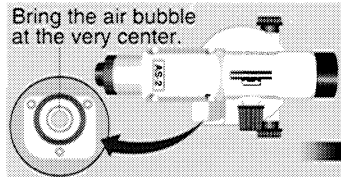
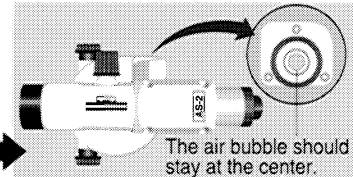


Fig. 10



Adjusting

Use the leveling screws to move back the air bubble half the way of its displacement.

Then, use the supplied hexagonal wrench to turn the circular level adjusting screws to move back the air bubble to the very center of the brown circle.

Check that the air bubble does not move away from the center of the brown circle whichever position the telescope is turned.

Fig. 11

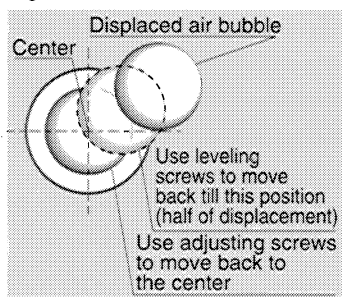
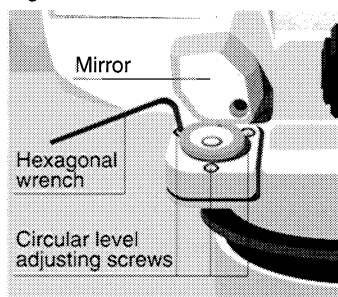


Fig. 12



Flip up the mirror (Refer to Fig.12) when adjusting the bubble position. Mirror can be turned 90°.

2. Horizontality of the line of sight

The line of sight seen through the eyepiece is etched on the reticle inside the eyepiece. This reticle should be set at the right position, or the line of sight will not show the exact horizontal line.

Checking

- (1) Set two rods F and R, 70 - 100m apart from each other. Set the instrument halfway between them. (Mount it on the tripod and bring the air bubble inside the brown circle.)
- (2) Sight two rods and take readings of rod F as F1, and rod R as R1. Calculate $F1 - R1$ to get the height difference between two points.
- (3) Reset the instrument at 2m distance from rod R. Sight two rods and take readings of rod F as F2, and rod R as R2. Calculate $F2 - R2$ to get the height difference between two points.
- (4) No adjustment is needed when $F1 - R1 = F2 - R2$. If $F1 - R1 \neq F2 - R2$, perform the adjustment.

Fig. 13

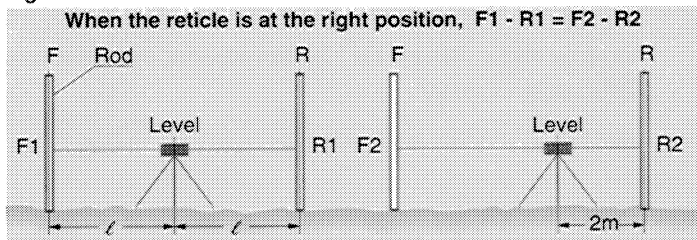
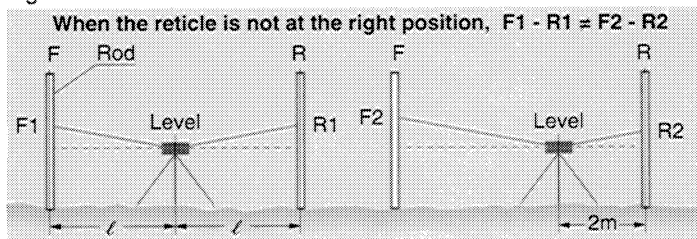


Fig. 14



Adjusting

- (1) Calculate $F3=R2+(F1-R1)$.
- (2) Screw off the reticle adjusting screw cover near the eyepiece.
- (3) Sight the distant rod (rod F). Adjust the reticle adjusting screw by the supplied hexagonal wrench to make the line of sight pointing out the F3.
- (4) Perform above checking to ensure that $F1-R1=F2-R2$.

Fig. 15

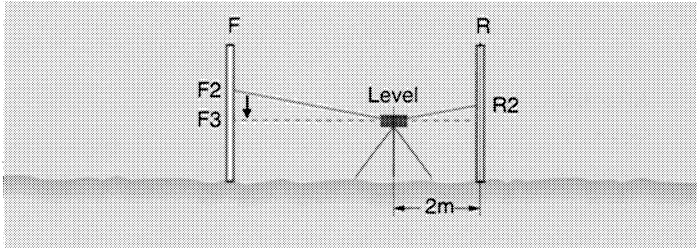
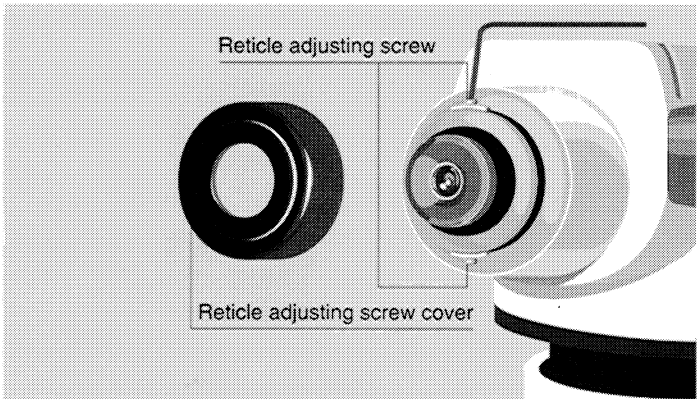


Fig. 16



IV

OPTIONAL ACCESSORIES



1. Plane parallel micrometer-3

Plane parallel micrometer-3 enables the parallel vertical translation of the optical axis. The amount of translation is indicated on the micrometer drum, thus enabling the fraction reading of the precision rod down to a unit of 0.1mm.

Attachable type

Measuring range: $\pm 5\text{mm}/100$ divisions

Minimum reading: 0.1mm/1 division

Measuring accuracy: within 0.05mm

Fig. 17

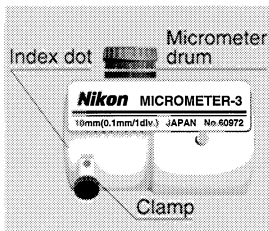
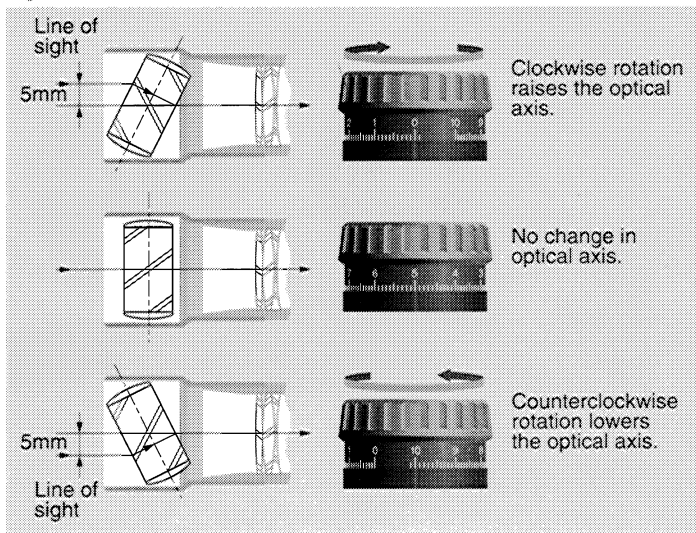


Fig. 18



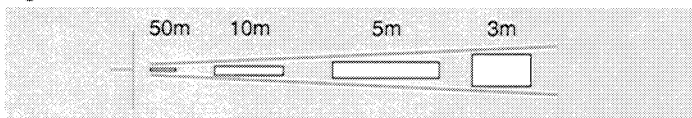
Usage

- (1) Attach the micrometer-3 to the object hood of a instrument. Match their index dots and clamp the micrometer-3.
- (2) Turn the micrometer drum to the position “5”. Sight the precision rod.
- (3) Look into the eyepiece to find the wedged lines on the right side of the viewfield.

Turn the micrometer drum clockwise or counterclockwise to bring a graduation line of the precision rod just in between the wedged lines. (Be sure to select a graduation line which is nearest to the wedged lines.)

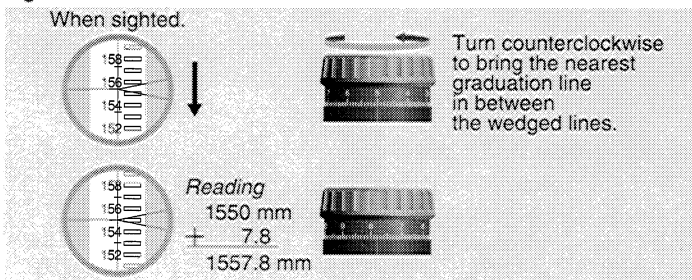
Since the image of the graduation lines appears thin or thick according to the distance between the rod and the instrument, use the appropriate openings of the wedged lines.

Fig. 19



- (4) Add the micrometer reading to the rod reading (read the graduation line in between the wedged lines).

Fig. 20



NOTE:

When plane parallel micrometer-3 is used, the measured height may not conform with the actual height of the position which is indicated by the line of sight, since the optical axis of the instrument is being translated. But the height difference of the two points can be calculated correctly since the measured height is always obtained in the same manner.



2. Illuminator-3

Illuminator-3 is used to light up the crosshairs inside the viewfield. It is useful in dark circumstances such as in night or in tunnel construction sites.

Attachable type

Power source:

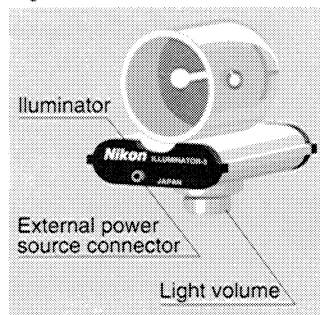
External power source , or

Two AA-type batteries (1.5V)
connected in series

Lamp bulb:

Specified miniature lamp bulb (3V)

Fig. 21



Usage

(1) When using batteries:

Remove the upper cover of the illuminator and set the batteries.

When using external power source:

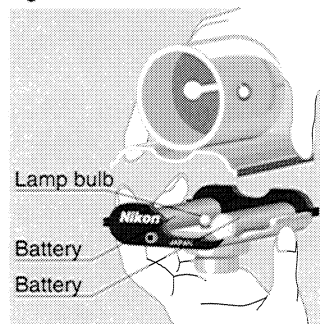
Use the specified cord to connect the external power source and the external power source connector on the illuminator.

(2) Attach the illuminator to the object hood of a instrument.

(3) Turn the light volume to light up the lamp and adjust its brightness.

(4) When exchanging the lamp, turn off the power and remove the upper cover of the illuminator. Wait till the lamp bulb cools enough before exchanging it.

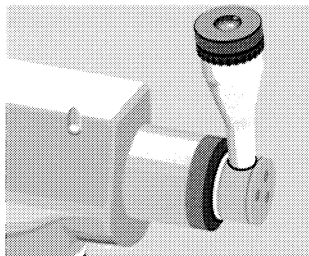
Fig. 22



3. Diagonal eyepiece prism

To install, unscrew the eyepiece and replace with the diagonal eyepiece prism, then mount the eyepiece onto the open end of the diagonal eyepiece prism.

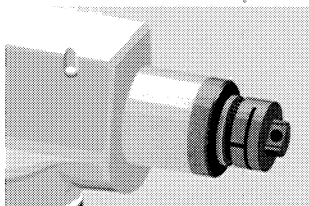
Fig. 25

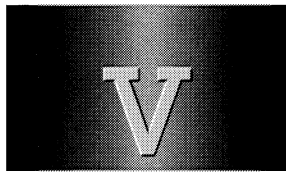


4. Zenith prism

Attach the zenith prism to the eyepiece.

Fig. 26





SPECIFICATIONS

Telescope

Internal focusing, anallactic optical system	
Image	Erect
Magnification	34X
Effective aperture of objective	45mm (1.77in)
Angle of viewfield (at 100m / 100ft)	1°20' (2.3m / 2.3ft)
Shortest focusing distance	1m (3.28ft)
Stadia multiplying constant	100
Stadia additive constant	0

Automatic level compensation range — ±12'

Sensitivity of circular level — 10'/2mm

Horizontal circle (AS-2C only) — Minimum increment 10' (10°)

Weight and dimensions

AS-2 Instrument	259 x 136 x 142, 1.80kg (10.2 x 5.4 x 5.6in, 4.0lb)
AS-2C Instrument	259 x 136 x 142, 1.90kg (10.2 x 5.4 x 5.6in, 4.2lb)
AS-2 Plastic case	379 x 195 x 197, 1.80kg (14.9 x 7.7 x 7.8in, 4.0lb)
AS-2C Plastic case	379 x 195 x 197, 1.90kg (14.9 x 7.7 x 7.8in, 4.2lb)

Complete equipment

Main body	1
Objective cap	1
Plastic case	1
Hexagonal wrench	2
Plumb bob (AS-2C only)	1

Trimble

5475 Kellenburger Road
Dayton, Ohio 45424-1099, U.S.A.
Phone +1-937-233-8921 • Fax +1-937-233-9004
www.trimble.com

TDS

Tripod Data Systems
PO Box 947
Corvallis, OR 97339, U.S.A.
Phone +1-541-757-7254 • Fax +1-541-752-7133
www.tdsway.com

Trimble Europe

Trimble GmbH
Am Prime Parc 11
65479 Raunheim, Germany
Phone +49-6142-2100-0 • Fax +49-6142-2100-550

Trimble Asia-Pacific

Trimble Navigation Singapore PTE Ltd.
80 Marine Parade Road
#22-06, Parkway Parade, 449269, Singapore
Phone +65 6348 2212 • Fax +65 6348 2232